

 **PEUGEOT**
MTG

CATALOGUE PIECES DE RECHANGE **BE**



SPXMA - RCXMA - RCXLMA

02/96

INDEX DE LA PARTIE				MOTEUR												A 01			
RUBRIQUES	TYPES	SPX	RCX	RCXL															
		MA	MA	MA															
CARBURATEUR		B01	B15	B13															
CARTER-P. COURROIE		B02	B02	B02															
CULASSE CYL. DECOMP.		B03	B03	B11															
ESCAPPEMENT		B04	B04	B04															
EMBIELLAGE-PISTON		B05	B05	B12															
ENBRAYAGE-POULIE		B06	B06	B06															
FIXATION MOTEUR		B07	B07	B07															
EIGE-LANCEUR		B08	B08	B08															
MOTEUR		A13	A13	A13															
RADIATEUR				B13															
VARIATEUR		B09	B09	B09															
VOLANT ET ALLUMAGE		B10	B10	B14															

INDEX DE LA PARTIE				CYCLE												A 02			
RUBRIQUES	TYPES	SPX	RCX	RCXL															
		MA	MA	MA															
CHASSIS-SELLE-CAPOTS		C01	C13	C13															
COMMANDES-CABLES		C02	C02	C02															
COMPOSANTS ELCT.		A14	A14	A14															
COMPTEUR		C03	C03	C03															
DECORS-COLORIS		A15	A15	A15															
ECLAIR. CLIGNOT. AVERT		C04	D03	D03															
EQUIPEMENT ELECT.		C05	C15	C15															
FOURCHE-DIR. ANTI-VOL.		C06	C06	C06															
GARDE BOUX AR. P. BAG		C07																	
GARDE BOUX ARRIERE			C16	C16															
GARDE BOUX AVANT		C08	C08	C08															
GUIDON-POIGNEES-RETE		C09	D01	D01															
OUTILAGE POMPE		A16	A16	A16															
BOUE-MOYEU AR. TRANSM		C10	C10	C10															
BOUE-MOYEU-AVANT		C11	C11	C11															
SUSPENSION-BEQUILLE		C12	D02	D04															











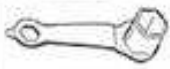

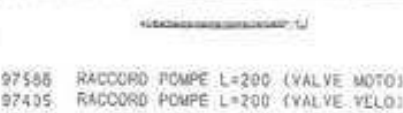

N°	REF. C	QTE	DESIGNATION	MOTEUR	A 13
1	735398	1	MOTEUR SYMA-RCOMA		
2	735237	1	MOTEUR NCLMA		

© PEGIBOT MOTOCYCLES

COMPOSANTS ELECT.				A 14																	
<p>2x</p> <p>PORTE-LANGUETTES</p> <table border="0"> <tr> <td>897140 9 voies 4,1</td> <td>897067 6 voies 4,1</td> <td>897065 4 voies 4,1</td> <td>897064 3 voies 4,1</td> <td>897052 2 voies 4,1</td> <td>897094 6 voies 6,3</td> <td>897173 4 voies 6,3</td> <td>897107 3 voies 6,3</td> <td>897083 1 voie 6,3</td> <td>700770 2 voies 6,3</td> </tr> </table>				897140 9 voies 4,1	897067 6 voies 4,1	897065 4 voies 4,1	897064 3 voies 4,1	897052 2 voies 4,1	897094 6 voies 6,3	897173 4 voies 6,3	897107 3 voies 6,3	897083 1 voie 6,3	700770 2 voies 6,3	<p>DERIVATION</p> <table border="0"> <tr> <td>702282</td> <td>702283</td> </tr> </table>	702282	702283					
897140 9 voies 4,1	897067 6 voies 4,1	897065 4 voies 4,1	897064 3 voies 4,1	897052 2 voies 4,1	897094 6 voies 6,3	897173 4 voies 6,3	897107 3 voies 6,3	897083 1 voie 6,3	700770 2 voies 6,3												
702282	702283																				
<p>PORTE-CLIPS</p> <table border="0"> <tr> <td>897136 9 voies 4,1</td> <td>897059 6 voies 4,1</td> <td>897057 4 voies 4,1</td> <td>897056 3 voies 4,1</td> <td>897054 2 voies 4,1</td> <td>897079 6 voies 6,3</td> <td>710614 6 voies 2,8</td> <td>897177 4 voies 6,3</td> <td>700100 4 voies 6,3</td> <td>59466 6 voies 5,3</td> <td>700099 2 voies 6,3</td> <td>897148 1 voie 6,3</td> </tr> </table>				897136 9 voies 4,1	897059 6 voies 4,1	897057 4 voies 4,1	897056 3 voies 4,1	897054 2 voies 4,1	897079 6 voies 6,3	710614 6 voies 2,8	897177 4 voies 6,3	700100 4 voies 6,3	59466 6 voies 5,3	700099 2 voies 6,3	897148 1 voie 6,3	<p>PROTECTEUR</p> <table border="0"> <tr> <td>897181 1 voie 6,3</td> <td>897184 1 voie 5</td> </tr> </table> <p>Transparent Vert</p>	897181 1 voie 6,3	897184 1 voie 5			
897136 9 voies 4,1	897059 6 voies 4,1	897057 4 voies 4,1	897056 3 voies 4,1	897054 2 voies 4,1	897079 6 voies 6,3	710614 6 voies 2,8	897177 4 voies 6,3	700100 4 voies 6,3	59466 6 voies 5,3	700099 2 voies 6,3	897148 1 voie 6,3										
897181 1 voie 6,3	897184 1 voie 5																				
<p>RACCORDEMENTS</p> <table border="0"> <tr> <td>751060-897036</td> </tr> </table>	751060-897036	<p>CLIPS</p> <table border="0"> <tr> <td>724575 6,3</td> <td>897034 6,3</td> <td>700628 6,3</td> <td>40511 5</td> <td>897029 6,3</td> <td>66805 4,8</td> <td>897048 4,1</td> <td>710616 2,8</td> </tr> </table>	724575 6,3	897034 6,3	700628 6,3	40511 5	897029 6,3	66805 4,8	897048 4,1	710616 2,8	<p>AGRAIFES</p> <table border="0"> <tr> <td>725728</td> <td>878024</td> <td>703822</td> <td>61930</td> <td>719775</td> </tr> </table>	725728	878024	703822	61930	719775					
751060-897036																					
724575 6,3	897034 6,3	700628 6,3	40511 5	897029 6,3	66805 4,8	897048 4,1	710616 2,8														
725728	878024	703822	61930	719775																	
<p>LANGUETTES</p> <table border="0"> <tr> <td>723134 6,3</td> <td>897059 6,3</td> <td>897047 4,1</td> <td>897045 4,1</td> </tr> </table>	723134 6,3	897059 6,3	897047 4,1	897045 4,1	<p>COSSSES</p> <table border="0"> <tr> <td>723364 ø 6,5</td> <td>897125 ø 6</td> <td>897207 ø 4</td> <td>727403 mâle</td> <td>727402 femelle</td> </tr> </table>	723364 ø 6,5	897125 ø 6	897207 ø 4	727403 mâle	727402 femelle	<p>BROCHES</p> <table border="0"> <tr> <td>710623 Mâle 3,6</td> <td>710624 Femelle 3,6</td> <td>728718 Femelle 2,4</td> </tr> </table>	710623 Mâle 3,6	710624 Femelle 3,6	728718 Femelle 2,4	<p>PASSE-FIL</p> <table border="0"> <tr> <td>31966 ø 6,5-2</td> </tr> <tr> <td>873023 ø 8-4</td> </tr> <tr> <td>873024 ø 10-6</td> </tr> <tr> <td>873070 ø 11-6</td> </tr> <tr> <td>873108 ø 11-8</td> </tr> <tr> <td>873029 ø 10-9</td> </tr> </table>	31966 ø 6,5-2	873023 ø 8-4	873024 ø 10-6	873070 ø 11-6	873108 ø 11-8	873029 ø 10-9
723134 6,3	897059 6,3	897047 4,1	897045 4,1																		
723364 ø 6,5	897125 ø 6	897207 ø 4	727403 mâle	727402 femelle																	
710623 Mâle 3,6	710624 Femelle 3,6	728718 Femelle 2,4																			
31966 ø 6,5-2																					
873023 ø 8-4																					
873024 ø 10-6																					
873070 ø 11-6																					
873108 ø 11-8																					
873029 ø 10-9																					
<p>GAINES</p> <table border="0"> <tr> <td>33359 ø 7,8</td> </tr> <tr> <td>59714 ø 11-13</td> </tr> <tr> <td>860691 ø 18-19</td> </tr> </table>	33359 ø 7,8	59714 ø 11-13	860691 ø 18-19	<p>COLLIERS</p> <table border="0"> <tr> <td>885008 larg 2,4</td> <td>L. 92</td> </tr> <tr> <td>885009 larg 3,0</td> <td>L. 100</td> </tr> <tr> <td>885010 larg 3,0</td> <td>L. 208</td> </tr> <tr> <td>885024 larg 3,6</td> <td>L. 281</td> </tr> </table>	885008 larg 2,4	L. 92	885009 larg 3,0	L. 100	885010 larg 3,0	L. 208	885024 larg 3,6	L. 281	<p>FIL ELECTRIQUE</p> <table border="0"> <tr> <td>(au mètre) 182</td> </tr> </table>	(au mètre) 182	<p>EMBOUT RETRACTILE</p> <table border="0"> <tr> <td>724476 ø 4,3</td> <td>728548 ø 6,3</td> </tr> </table>	724476 ø 4,3	728548 ø 6,3				
33359 ø 7,8																					
59714 ø 11-13																					
860691 ø 18-19																					
885008 larg 2,4	L. 92																				
885009 larg 3,0	L. 100																				
885010 larg 3,0	L. 208																				
885024 larg 3,6	L. 281																				
(au mètre) 182																					
724476 ø 4,3	728548 ø 6,3																				

© PEGIBOT MOTOCYCLES

COLORIS DU VEHICULE	I N D	REFERENCES		REFERENCES JEUX DE DECORS			A 15
		STYLO RETOUCHE	AEROSOL PEUGEOT	SPXMA	RCXMA	RCXLMA	
NOIR	N	68700 N	68900 N	752930	752961	752961	
MAJIC BLUE	MB	68700 MB	68900 MB	752947			
JAUNE FORMULA	JP	68700 JP	68900 JP		752945	752945	

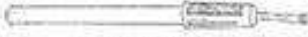
OUTILLAGE POMPE					A 16
 40596 CLE A BOUGIE	 18225 CLE 6-10	 1105 BOITE DE RUSTINES	 714540 CLE 6 PANS DE 6	 532 NECESSAIRE DE REPARATION	
 732666 TROUSSE COMPLETE D'OUTILLAGES COMPOSEE DE : SANDOW CLE TORX T10 CLE TORX T20 CLE TORX T30 CLE A BOUCHE 6 PANS DE 21 TOURNEVIS LAME DOUBLE		 97586 RACCORD POMPE L=200 (VALVE MOTO) 97495 RACCORD POMPE L=200 (VALVE VELO)		 33202 RACCORD VALVE	
		 752225 TOURNEVIS AVEC 2 LAMES	 62410 DEMONTE PNEUMATIQUE	 713102 CLE PLATE 10-12	
 726606 CLE A BOUGIE	 45102 DEMONTE-PNEU	 52722 TROUSSE A OUTILS	 750455 POMPE 300-22 (VALVE VELO) 702790 POMPE 300-22 (VALVE MOTO) 750468 POMPE 300-22 (VALVE MOTO)		

© PEUGEOT MOTORCYCLES

N°	REF. C	QTE	DESIGNATION	CARBURATEUR	B 01
1	725634	1	CARBURATEUR GA14 R227		
2	720372	1	SILENCIEUX		
3	7203	1	COLLIER AVEC VIS ET ECROU		
4	7080	1	CARTOUCHE FILTRANTE		
5	808001	1	VIS CBL MAXO,70-10 AVEC RONDELLE DE		
6	856060	1	RONDELLE DENTURE INTERIEURE D-6		
7	705101	1	VIS CB MSX0,80-12		
8	6720	1	JOINT		
9	85335	1	COUVERCLE DE FILTRE		
10	7145	1	JOINT DE CARBURATEUR		
11	7144	1	FILTRE A ESSENCE		
12	751467	1	CHAPEAU DE CHAMBRE COMPLY		
13	7140	1	RESSORT VOLNT DES GAZ		
14	85333	1	VOLET DE GAZ		
15	7087	1	JOINT DE DIFFUSEUR		
16	751417	1	VIS DE BUTEE AVEC RESSORT		
17	751450	1	ENS. VIS/ECROU/RONDELLE DE CARB.		
18	7080	1	JOINT DE CARBURATEUR		
19	750868	1	JOINT DE CUVE EXTERIEUR		
20	751681	1	GICLEUR DE RALENTI 50		
21	750453	1	POINTEAU L-16,8 (CORPS EN INOX)		
22	751689	1	FLOTTEUR		
23	7079	1	AXE DE FLOTTEUR		
24	750869	1	JOINT DE CUVE INTERIEUR		
25	751559	1	CUVE AVEC JOINT		
26	751606	1	GICLEUR DE 74		
27	751470	1	DIFFUSEUR 50		
28	721308	1	COMMANDE DE GAZ		

© PEUGEOT MOTORCYCLES

N°	REF. C	QTE	DESIGNATION	CARTER-P. COURROIE	B 02
1	750357	1	CARTERS D/C AVEC JOINTS/ROULEMENTS	<p>* NE PAS OMETTRE DE PRECISER LE COLORIS</p>	
2	47224	1	JOINT DE CARTER		
3	801131	2	VIS A BOMASE H M6X1,00-65		
4	801130	2	VIS A BOMASE H M6X1,00-60		
5	58141	1	VIS A BOMASE H M5,8X1,00-65		
6	58185	1	VIS A BOMASE H M6X1,00-70		
7	853331	3	RONDELLE PLATE 6,2-12-1,2		
8	856060	3	RONDELLE DENTURE INTERIEURE D-6		
9	832087	6	ECROU H 6X1,00		
10	707712	4	COUSON 7-97-15		
11	723693	3	VIS A BOMASE H MSX0,80-20		
12	709463	1	VIS A BOMASE H MSX0,80-50		
13	718538	2	RACCORD DE CARBURATEUR D-15,5		
14	50490	1	JOINT DE CLAPET		
15	701564	1	CLAPET (OUVERTURE 89%)		
16	47241	1	JOINT DE CLAPET		
17	718215	1	SUPPORT PARE-COURROIE		
18	705429	1	PLAQUE ARRET DE JOINT		
19	709485	2	VIS F/83 MAXO,70-10		
20	723269 *	1	PARE-COURROIE		
21	717855	4	VIS CHC MSX0,80-20		
22	853101	4	RONDELLE PLATE 5-10-1		
23	708381	2	ECROU TOLX 3X0,80		
24	712833	1	DECOR *110H*		

© PEUGEOT MOTORCYCLES

N°	REF. C	QTE	DESIGNATION	CULASSE CYL. DECOMP.	B 03
1	710341	1	CULASSE AVEC DECOMPRESSEUR		
2	732649	1	JOINT DE CULASSE		
3	858011	4	RONDELLE RESSORT 7-14-1,4		
4	832115	4	ECROU IH 7X1,00		
5	751385	1	CYLINDRE/PISTON		
6	709148	1	JOINT DE CYLINDRE		
7	713158	1	JOINT D'ECHAPPEMENT		
8	51012	1	DECOMPRESSEUR		
9	31132	1	JOINT		
10	32135	1	AXE		
11	40594	1	JOINT TORIQUE 2,4-1,9		
12	48951	1	POCHETTE DE JOINTS(CYL.CUL.ADM.MCH)		

© PEUGEOT MOTOCYCLES

N°	REF. C	QTE	DESIGNATION	ECHAPPEMENT	B 04
1	719834 *	1	POT D'ECHAPPEMENT A BRIDE	<p>* NE PAS OMETTRE DE PRECISER LE COLORIS</p>	
2	713158	1	JOINT D'ECHAPPEMENT		
3	801131	1	VIS A EMBASE H M6X1,00-65		
4	712981	1	ECROU RONDELLE 6X1,00		
5	716162	3	RONDELLE RESSORT 6,1-14-1,3		
6	718561	1	ENTRETOISE 10-8-46,2		
7	714937	1	VIS H M6X1,00-23		
8	714938	2	ECROU Q M6X1,00 KP-5		
9	719921	1	VIS INDEMONTEBLE M6X1,00-28		

© PEUGEOT MOTOCYCLES

N°	REF. C	QTE	DESIGNATION	EMBIELLAGE-PISTON	B 05
1	720721	1	EMBIELLAGE		
2	54198	1	CAGE A AIGUILLES 12-15-17,5		
3	14403	1	ROULEMENT A BILLES 20-47-14		
4	37004	1	JOINT A LEVRE 20-30-4,5		
5	14292	1	ROULEMENT A BILLES 17-40-12		
6	37616	1	JOINT A LEVRE 16-30-4,5		
7	711556	1	CLAVETTE BATEAU		
8	64818	1	PISTON LETTRE A		
9	64819	1	PISTON LETTRE B		
10	64820	1	PISTON LETTRE C		
11	64821	1	PISTON LETTRE D		
12	64822	1	PISTON LETTRE E		
13	64823	1	PISTON LETTRE F		
14	64824	1	PISTON LETTRE G		
15	64825	1	PISTON LETTRE H		
16	64826	1	PISTON LETTRE I		
17	721931	1	AXE DE PISTON L.33		
18	22309	2	CIRCLIPS INTERIEUR 13-1		
19	66490	2	SEGMENT D-40 EP.1,5		
20	703144	2	SEGMENT D-40,5 EP.1,5		
21	711998	2	JONG		

© PEUGEOT MOTOCYCLES

N°	REF. C	QTE	DESIGNATION	EMBRAYAGE-POULIE	B 06
1	723806	1	POULIE RECEPTRICE		
2	751834	1	ENS. BLOCAGE EMBRAYAGE		
3	715922	1	CLIPS		
4	716449	1	INDIX		
5	718794	2	RONDELLE PLATE 6-18-0,3		
6	715386	3	ANNEAU D'ARRET 3 POINTS 6,3-0,7		
7	715378	1	PLAQUE RENFORT		
8	715385	3	RONDELLE ONDULEE 9,1-13,4-0,2		
9	715431	3	AMORTISSEUR MASSELOTTE		
10	715814	3	RESSORT DE MASSELOTTE		
11	723518	3	MASSELOTE		
12	718317	1	DEFLECTEUR		
13	722481	1	RONDELLE 16,1-23-1		
14	722521	1	RONDELLE ELASTIQUE 16,5-22,5-0,15		
15	718843	1	RONDELLE PLATE 16-27-1		
16	716905	1	MOYEU DE POULIE		
17	49459	2	DOUILLE A AIGUILLES L-14		
18	716766	1	ECROU H 30X1,00 H=5 41/PLAT		
19	716818	1	RONDELLE FREIN 30,4-50-0,6		
20	721021	1	POULIE RECEPTRICE		
21	722706	1	CLOCHE D'EMBRAYAGE		
22	54967	2	RONDELLE NYLON 16,5-28-2		
23	751460	1	PIGNON 10 DENTS AVEC ANNEAUX		
24	714448	1	ANNEAU AMORTISSEUR DROIT		
25	714449	1	ANNEAU AMORTISSEUR GAUCHE		
26	866127	1	CIRCLIPS EXTERIEUR 11,9-1		
27	751718	1	COUVERTOIL TRAPEZOIDALE 15,5X8 L-743		
28	720144	2	RONDELLE CONIQUE 6-11,7-0,3		
29	720685	1	AXE D'ENS. BLOCAGE EMBRAYAGE		
30	720660	3	ANNEAU AMORTISSEUR		
31	720143	1	ANNEAU D'ARRET 3 POINTS D-6		

© PEUGEOT MOTOCYCLES

N°	REF. C	QTE	DESIGNATION	FIXATION MOTEUR	8 07
1	715502	1	PLAQUE SUP. MOTEUR AVEC SILENTBLOCS		
2	715281	2	SILENTBLOC		
3	715189	1	VIS H M6X1,25-78		
4	750761	2	ECROU FI 6X1,25		
5	715057	1	BUTE		
6	717567	1	PATTE REACTION DE RESSORT		
7	717561	1	PATIN APPUI RESSORT		
8	710287	1	VIS H M6X1,00-16		
9	710374	1	ECROU FI 6X1,00		
10	718039	1	BIELLETTE		
11	51220	1	ENTRETOISE		
12	719325	2	RONDELLE EPAULES 16,5-22-3,5-1,6		
13	735451	1	VIS M6X1,25-110		
14	725083	1	RONDELLE CONIQUE 8,4-10-1,4		
15	735690	1	ENTRETOISE		
16	716880	1	PATIN		
17	716793	1	RESSORT DE TORSION		
18	719611	1	FOURNEAU		
19	41083	2	BUTE CAOUTCHOUC		

© PEUGEOT MOTOCYCLES

N°	REF. C	QTE	DESIGNATION	KICK-LANCRON	8 08
1	725936	1	AXE DE KICK (AVEC CORCE)	<p>* NE PAS OUBLIER DE PRECISER LE COULEUR</p>	
2	712390	1	MANGON		
3	716358	1	RESSORT		
4	714691	1	PIGNON DE LANCENENT		
5	718570	1	RONDELLE PLATE 12,35X19,75X1		
6	716689	1	ANNEAU D'ARRRET 3 POINTS 9,5-0,8		
7	706299	1	RESSORT		
8	714485	1	SOUFFLET PROTECTION		
9	725933	1	COUPLETTA ENTRETOISE JAUNE		
10	715509	1	BUTE DE KICK CAOUTCHOUC		
11	866078	1	CIRCLIPS EXTERIEUR 14,6-1		
12	715835	1	PROTECTEUR		
13	705192	3	VIS CBL. AUTOTARAUSEUSE M6X12		
14	716120 *	1	CAPOT		
15	801005	2	VIS H M6X0,70-20		
16	717715	1	PEDALE DE KICK		
17	809002	1	VIS CBL M6X1,00-20		
18	716250	1	LEVIER MARCHI		
19	716384	1	RONDELLE ONDULEE 7,3-13,9-0,3		
20	853466	1	RONDELLE PLATE 3,25-14-1,3		
21	834007	1	ECROU FI 5X0,60		
22	716251	1	RESSORT		
23	716255	1	CLIQUET		
24	713193	1	AXE DE CLIQUET		
25	716253	1	LEVIER AUTOMATIQUE		
26	716075	1	PROTECTEUR DE GAMME		
27	717472	1	MANGON CAOUTCHOUC		

© PEUGEOT MOTOCYCLES

N°	REF. C	QTE	DESIGNATION	VARIATEUR	B 08
1	717498	1	POULIE MOTRICE		
2	720723	1	RONDELLE D'OSSEYAYAGH 12,5-24-2,5		
3	716081	1	PLAQUE MOBILE		
4	751657	1	CANON DE VARIATEUR		
5	715746	1	PLAQUE FIXE		
6	719698	1	ENTRAINEUR DE VARIATEUR		
7	48696	2	AXE D'ARTICULATION		
8	48699	2	FKKIN D'AXE		
9	711218	2	MASSELOTTE		
10	717496	1	SUPPORT MASSELOTTE		
11	718879	1	RONDELLE NYLON 18,2-26-0,51		
12	53526	1	RONDELLE EPAULEE 11,05-26-6-2,5		
13	728042	1	ECROU EMBASE HM10X1,75		
14	48680	4	DOUILLE DE MASSELOTTE		
15	732825	2	BUTEE		
16	718570	1	RONDELLE PLATE 12,35X19,75X1		
17	739273	1	FKKIN D'AXE		
18	732839	1	ENS.AXE+FKKIN D'AXE		
19	719856	1	BAQUE DE VARIATEUR		

© PEUGEOT MOTOCYCLES

N°	REF. C	QTE	DESIGNATION	VOLANT ET ALLUMAGE	B 10
1	715484	1	MOTOR		
2	46768	1	ECROU EN 10X1,00		
3	715486	1	ENSEMBLE INDUIT		
4	705001	2	VIS A EMBASE H M5X0,80-25		
5	711136	1	CAPTEUR ELECTRONIQUE		
6	704937	2	VIS A EMBASE H M6X1,00-12		
7	60938	1	BOBINE 10W DE CLIGNT.OU D'AVERTIS.		
8	63628	1	BOBINE 15W		
9	717367	1	BOBINE D'ALLUMAGE		
10	715330	1	PLAQUE STATOR		
11	723695	2	VIS A EMBASE H M5X0,80-20		
12	728846	1	VIS/EDL M6X0,70-8		
13	715329 *	1	COUVERCLE DE VOLANT		
14	38485	2	ATTACHE SOUPLE		
15	716099 *	1	DECOR CACHE-VOLANT		
16	727101	1	BOBINE EXTERIEURE AVEC FIL		
17	801137	3	VIS H M5X0,80-25		
18	856096	1	RONDELLE DESTURE INTERIEURE L.D-5		
19	717245	1	PLAQUE ATTACHE GAINE		
20	731973	1	CAPUCHON PROTECTEUR		
21	709205	1	BLOC CDI		
22	717916	1	SANGLE DE BLOC CDI		
23	703207	1	CALC ADHESIVE DOUBLE FACE		
24	716057	1	CAPUCHON DU BLOC D'ALLUMAGE		
25	35478	1	PASSE FIL		
26	713487	1	ANTIPARASITE ETANCHE		
27	39836	1	MANCHON PLASTIQUE		
28	53559	1	GAINE 7-8 (AU METRE)		
29	705529	1	BOUCLE *KVAS 850*		
30	715487	1	FAISCEAU DE SORTIE VOLANT ELECTRO.		
31	897057	1	PORT-CLIPS 4,1-4VOIES		
32	897048	4	CLIF 4,1		

* NE PAS OMETTRE DE PRECISER LE COLORIS

© PEUGEOT MOTOCYCLES

N°	REP.	C	QTE	DESIGNATION	CULASSE CYL. DECOMP.	B 11
1	718677 *		1	CULASSE AVEC DECOMPRESSEUR	<p>* NE PAS OMETTRE DE PRECISER LE COLORIS</p>	
2	858011		4	RONDELLE RESSORT 7-14-1,4		
3	832115		4	ECROUS HM 7X1,00		
4	752276		1	CYLINDRE / PISTON		
5	709148		1	JOINT DE CYLINDRE		
6	732649		1	JOINT DE CULASSE		
7	708241		1	JOINT TORIQUE 133-3,5		
8	713158		1	JOINT D'ECHEAPPMENT		
9	51012		1	DECOMPRESSEUR		
10	31152		1	JOINT		
11	32133		1	AXE		
12	40594		1	JOINT TORIQUE 2,6-1,9		
13	751830		1	POCHETTE DE JOINTS		

© PEUGEOT MOTOCYCLES

N°	REP.	C	QTE	DESIGNATION	EMBIELLAGE-PISTON	B 12
1	720721		1	EMBIELLAGE		
2	54198		1	CAGE A AIGUILLES 12-15-17,5		
3	14403		1	BOULONNET A BILLES 20-47-24		
4	37004		1	JOINT A LEVRE 20-30-4,5		
5	14292		1	BOULONNET A BILLES 17-40-12		
6	37616		1	JOINT A LEVRE 16-30-4,5		
7	711556		1	CLAVETTE BATEAU		
8	750377		1	PISTON LETTRE A		
9	750378		1	PISTON LETTRE B		
10	750379		1	PISTON LETTRE C		
11	750380		1	PISTON LETTRE D		
12	750381		1	PISTON LETTRE E		
13	750382		1	PISTON LETTRE F		
14	750383		1	PISTON LETTRE G		
15	750384		1	PISTON LETTRE H		
16	750385		1	PISTON LETTRE I		
17	750386		1	PISTON LETTRE II		
18	721931		1	AXE DE PISTON L:33		
19	22309		2	CIRCLIPS INTERIEUR 13-1		
20	68490		2	SEGMENT D-40 EP.1,5		
21	703164		2	SEGMENT D-40,3 EP.1,5		
22	712998		2	JOINT		

© PEUGEOT MOTOCYCLES

N°	REF. C	QTE	DESIGNATION	RADIATEUR	B 13
1	711731	2	COLLIER CLIC D-22	<p>* NE PAS OMETTRE DE PRECISER LE COLORIS</p>	
2	719313	1	DORITE DE CYLINDRE		
3	883227	2	COLLIER 20/30		
4	705425	1	DOUILLE		
5	710282	1	VIS H M5X0,80-16		
6	711790	2	PASSE CAINE 13-9,5		
7	725693	1	VIS A EMBASE H M5X0,80-20		
8	734592	1	PATTE		
9	832085	2	ECROU H 5X0,80		
10	853086	2	RONDELLE PLATX 6,2-12-1		
11	708301	4	ECROU TOLE 5X0,80		
12	722453	1	TUYAU D'EVACUATION		
13	725129	1	DORITE CULASSE		
14	725266	1	RADIATEUR *KTM* + BOUCHON		
15	752279	1	BOUCHON RADIATEUR *KTM*		
16	735025 *	1	CACHE RADIATEUR DROIT		
17	735030 *	1	CACHE RADIATEUR GAUCHE		
18	860901	4	RONDELLE RILSAN 5-13-1		
19	728544	4	VIS RLX M5X0,80-20		
20	734258	1	SUPPORT RADIATEUR		
21	726442	2	VIS RLX M5X0,80-13		

© PEUGEOT MOTOCYCLES

N°	REF. C	QTE	DESIGNATION	VOLANT ET ALLUMAGE	B 14
1	715484	1	ROTOR	<p>* NE PAS OMETTRE DE PRECISER LE COLORIS</p>	
2	46768	1	ECROU BS 10X1,00		
3	715486	1	ENSEMBLE INDUIT		
4	703001	2	VIS A EMBASE H M5X0,80-25		
5	711136	1	CAPTEUR ELECTRONIQUE		
6	704937	2	VIS A EMBASE H M6X1,00-13		
7	60938	1	BOBINE 10W DE CLIGNT.OU D'AVERTIS.		
8	63628	1	BOBINE 15W		
9	717367	1	BOBINE D'ALLUMAGE		
10	715338	1	PLAQUE STATOR		
11	723695	2	VIS A EMBASE H M5X0,80-20		
12	728846	1	VIS/REL 5MAX0,70-8		
13	715329 *	1	COUVERCLE DE VOLANT		
14	38485	2	ATTACHE SOUPLE		
15	716099 *	1	DESCO CACHE-VOLANT		
16	727101	1	BOBINE EXTERIEURE AVEC VIL		
17	801137	1	VIS H M5X0,80-25		
18	856096	1	RONDELLE DISTANCE INTERIEURE L.D-5		
19	717245	1	PLAQUE ATTACHE CAINE		
20	731973	3	CAPUCHON PROTECTEUR		
21	709205	1	BLOC CDI		
22	717916	1	SANGLE DE BLOC CDI		
23	703207	1	CALX ADHESIVE DOUBLE FACE		
24	716057	1	CAPUCHON DU BLOC D'ALLUMAGE		
25	55478	1	PASSE FIL		
26	713487	1	ANTIPARASITE BLANCHE		
27	39636	1	MANCHON PLASTIQUE		
28	53359	1	GAINES 7-8 (AU METRE)		
29	711999	1	BOUGIE *EAS 805L*		
30	715487	1	FAISCEAU DE SORTIE VOLANT ELECTRO.		
31	897057	1	PORTE-CLIPS 4,1-AVOIES		
32	897046	4	CLIP 4,1		

© PEUGEOT MOTOCYCLES

N°	REF. C	QTR	DESIGNATION	CARBURATEUR	B 15
1	735977	1	CARBURATEUR GAIA		
2	714522	1	SILENCIEUX D'ADMISSION AVEC COLLIER		
3	7203	1	COLLIER AVEC VIS ET ECROU		
4	7080	1	CARTOUCHE FILTRANTE		
5	806001	1	VIS CBL MAXI,70-10 AVEC RONDELLE DE		
6	856060	1	RONDELLE DENTURE INTERIEURE D=4		
7	705101	1	VIS CB M5X0,80-12		
8	6728	1	JOINT		
9	85333	1	COUVERCLE DE FILTRE		
10	7145	1	JOINT DE CARBURATEUR		
11	7144	1	FILTRE A ESSENCE		
12	751467	1	CRAPAUD DE CHAMBRE COMPLET		
13	7140	1	RESSORT VOLET DES GAZ		
14	85333	1	VOLET DE GAZ		
15	7087	1	JOINT DE DIFFUSEUR		
16	751417	1	VIS DE BUTEE AVEC RESSORT		
17	751438	1	ENS. VIS/ECROU/RONDELLE DE CARR.		
18	7088	1	JOINT DE CARBURATEUR		
19	750888	1	JOINT DE CUVRE EXTERIEUR		
20	751681	1	GICLAGEUR DE RALENTI 36		
21	750453	1	POINTEAU L-16,8 (CORPS EN INOX)		
22	751689	1	FLOTTEUR		
23	7079	1	AXE DE FLOTTEUR		
24	750869	1	JOINT DE CUVRE INTERIEUR		
25	751559	1	GUVK AVEC JOINT		
26	751606	1	GICLAGEUR DE 74		
27	751470	1	DIFFUSEUR 50		
28	735989	1	COMMANDE DE GAZ		

© PEUGEOT MOTOCYCLES

N°	REF. C	QTR	DESIGNATION	CHASSIS-SELLE-CAPOTS	C 01
1	752936 *	1	CHASSIS		
2	58359	2	ACRAPE		
3	708381	3	ECROU TOLX 520,80		
4	44312	1	SILENTBLOC		
5	714410 *	1	PARE-CHAINE		
6	726456	2	VIS T45 RLX 4-14		
7	725507	2	VIS DE MS X 0,80 - 10		
8	727040 *	1	ENS PARE-CHAINE		
9	853349	2	RONDELLE PLATE 3,25-12-1		
10	18857	1	GRAISSSEUR		
11	752334 *	1	PAIRE DE COFFRES (PEINT)		
12	752894 *	1	PAIRE DE COFFRES (TEINTE MASSE)		
13	726544	3	VIS RLX M5X0,80-20		
14	65857	1	ECROU FILTREUR 5		
15	52265	2	DOUILLE A AIGUILLES L-18		
16	752929 *	1	PAIRE DE CAPOTAGES (TEINTE MASSE)		
17	752944 *	1	PAIRE DE CAPOTAGES (PEINT)		
18	726442	1	VIS RLX M5X0,80-12		
19	700801 *	1	SELLE		
20	4635 *	1	DRESSUS DE SELLE		
21	718922 *	1	SOUFFLET DE SELLE		
22	716666 *	1	BOUCHON DE RESERVOIR		
23	752959	1	BOBINET D'ESSENCE		
24	51383 *	1	ENVELOPPE CENTRAL		
25	81764	1	TUYAU (AU METRE)		
26	872077	2	RIVET AVEUGLE 3,2		
27	716276 *	1	COUVERCLE PROTECTRICE		
28	801241	1	VIS H M5X1,25-45		
29	833100	1	RONDELLE PLATE 8,25-16-1,5		

* NE PAS OMETTRE DE PRECISER LE COLORIS

© PEUGEOT MOTOCYCLES

N°	REF. C	QTE	DESIGNATION	COMMANDES-CABLES	C 02
1	751506	2	CABLE DE FREIN D=2 L=1850	<p style="text-align: center;">TENDEURS DE GAINÉ</p> <p style="text-align: center;">EMBOUTS DE GAINÉ</p> <p style="text-align: center;">SERRE-CABLES</p>	
2	751504	2	CABLE DE FREIN D2 L=1900		
3	751935	2	CABLE DE FREIN D1,80 L=1900		
4	700644	3	CABLE AVEC GRAIN D1,5 L=1150		
5	717961	2	TENDEUR DE GAINÉ		
6	750226	4	TENDEUR DE GAINÉ		
7	61826	1	EMBOUT DE GAINÉ		
8	720643	2	EMBOUT DE GAINÉ		
9	40002	2	SERRE-CABLE		
10	37817	1	SERRE-CABLE		
11	38583	2	SERRE-CABLE		
12	55434		GAINÉ POUR CABLE D=1,2-1,5		
13	751289		TUBE DE GAINÉ POUR CABLE D=1,2-1,5		
14	751491		GAINÉ POUR CABLE D=2 ET D=1,8		
15	751492		TUBE DE GAINÉ POUR CABLE D=2 & 1,8		
16	701897		CABLE AVEC GAINÉ D1,2 1310		
<p>CABLES Ø 1,8 FREINS AV. et AR.</p> 751936 (MAGURA) 1900 751037 (DOMINO) 1900 751935 (CLB) 1900					
<p>CABLES Ø 1,5 FREINS AV. et AR.</p> 716357 (DOMINO) 1140 48512 (CLB) 1700				<p>CABLES Ø 2 FREINS AV. et AR.</p> 751506 (MAGURA) 1900 751504 (DOMINO) 1900 751505 (CLB) 1900	
<p>COMMANDES AUTO-LUBRIFIEES</p> <p>GAINÉ 55434 Ø 2,0 - 4,9 TUBE DE GAINÉ 751289 EMBOUT DE GAINÉ 44526</p>				<p>COMMANDES AUTO-LUBRIFIEES</p> <p>GAINÉ 751491 TUBE DE GAINÉ 751492 EMBOUT DE GAINÉ 751495</p>	
<p>COMMANDE</p> <p>GAINÉ 53408 Ø 2,3 - 4,7 GAINÉ 717696 14X16 AU METRE (gaine pour passage commande)</p>				<p>CABLES AIR - DECOMPRESSEUR - GAZ</p> 701897 Ø 1,2 1310 711572 Ø 1,2 1240 700644 Ø 1,6 1180 58178 Ø 1,5 1030 58372 Ø 1,5 950	
<p>© PIERROT MOTOCYCLES</p>					

N°	REF. C	QTE	DESIGNATION	COMPTEUR	C 03
1	753447	1	COMPTEUR D=60 *FACOMSA*	<p>* NE PAS OMETTRE DE PRECISER LE COLORIS</p>	
2	733868	1	DISMULTIPLICATEUR FACOMSA 1,6		
3	735847	1	COMMANDE DE COMPTEUR		
4	727784 *	1	SUPPORT COMPTEUR		
5	720074 *	1	BOUCHON		
6	719515	1	BOUCHON		
7	724384	1	TABLEAU DE BORD		
8	726712	1	ECROU M4 10X1,00		
9	873113	1	PASSE GAINÉ 17-13		
10	726455	3	VIS T45 M4X5 5-12		
11	725200	1	BRIDE COUPELLE		
12	726711	1	ENTRETOISE 15,1 X 19 X 14		
<p>© PIERROT MOTOCYCLES</p>					

N°	REF. C	QTE	DESIGNATION	REGATR-CLIGNOT-AVERT	C 04
1	733232	1	BLOC OPTIQUE AVEC AMPOULE	<p>* NE PAS OMETTRE DE PRECISER LE COLORIS</p>	
2	47008	1	AMPOULE BLANCHE 6V-15W P26S		
3	732785	2	VIS ELKS 4-12		
4	751719 *	1	CARENAGE DE PEARE AVEC CATADIOPTRES		
5	716882	1	BRIDE		
6	705425	1	DOUILLE		
7	716933	1	CATADIOPTRE GAUCHE		
8	716934	1	CATADIOPTRE DROIT		
9	731255	1	AVERTISSEUR		
10	51856	1	BOUTON AVERTISSEUR		
11	726479	2	VIS T4S ELKS 4-10		
12	718524	1	LANTERNE AR AVEC AMPOULES		
13	57892	1	AMPOULE BLANCHE 6V-4W BA9S		
14	57893	1	AMPOULE BLANCHE 6V-10W BA15S		
15	751096	1	CASOCHON		
16	751154	2	VIS DE CASOCHON L=54		
17	710287	2	VIS H MAXI,00-16		
18	856097	2	RONDELLE DENTURE INTERIEURE L.D=6		
19	837013	2	ECROU ELK MBASE 6X1,00		
20	718510	1	PLAQUE		
21	853466	1	RONDELLE PLATE 5,25-14-1,5		
22	873123	1	PASSE-GAINN 11-8		
23	728540	3	VIS ELKS 4-20		

© PEUGEOT MOTOCYCLES

N°	REF. C	QTE	DESIGNATION	EQUIPEMENT ELKCP.	C 05
1	717363	1	FAISCEAU PRINCIPAL (NON REPRESENTE)		
2	878024	3	AGRAFE 6/7		
3	63357	1	CONTACTEUR DE STOP		
4	56310	1	CAPUCHON		
5	65767	1	TRANSFORMATEUR *G*		
6	63156	1	ENTRETOISE		
7	851102	1	VIS H MAXI,00-20		
8	853086	1	RONDELLE PLATE 6,2-12-1		

© PEUGEOT MOTOCYCLES

N°	REP.	C	QTE	DESIGNATION	FOURCHE-DIR-ANTIVOI	C 06
1	752946	*	1	FOURCHE TELESCOPIQUE	<p>* NE PAS OMETTRE DE PRECISER LE COLORIS</p>	C 06
2	64319	*	1	PLATINE SUPERIEURE		
3	751302	*	1	PLATINE INFERIEURE AVEC DOUILLE		
4	714291		2	TUBE SUPERIEUR		
5	734636	*	1	TUBE INFERIEUR GAUCHE		
6	734639	*	1	TUBE INFERIEUR DROIT		
7	710372		2	ECROU H 8X1,25		
8	54044		2	CACHE POUSSIERE		
9	54045		2	RESSORT		
10	64330		2	BONDELLE BUTEE		
11	710467		2	VIS H M6X1,25-55		
12	725083		4	BONDELLE CONIQUE 8,4-16-1,4		
13	718939		2	ECROU *TWOLOK* 8X1,25		
14	62370		2	BUSHON PROTECTION DR B		
15	51974		1	JEU DE DIRECTION		
16	719372		1	SUPPORT ANTIVOI		
17	51646		1	CONTRE-ECROU DE DIRECTION		
18	708624		1	BONDELLE PLATE 25,5-36-1,5		
19	731949		1	CONE REGLABLE		
20	91770		1	CUVETTE SUPERIEURE		
21	46840		1	CUVETTE INFERIEURE		
22	57123		1	CONE INFERIEUR DE DIRECTION		
23	718587		1	CAGE A BILLE		
24	700612		25	BILLE D-3,969		
25	751603		1	SUPPORT ANTIVOI		
26	718945		1	CAPUCHON CAOUTCHOUC		
27	712041		1	BARREAU ANTIVOI L-145		
28	733942		1	GUIDE GAINE		

© PEUGEOT MOTOCYCLES

N°	REP.	C	QTE	DESIGNATION	GARDE BOUE AR P.BAG	C 07
1	726980	*	1	GARDE BOUE ARRIERE	<p>* NE PAS OMETTRE DE PRECISER LE COLORIS</p>	C 07
2	718269		1	RAVETTE ARRIERE		
3	710282		1	VIS H M5X0,80-16		
4	710287		2	VIS H M6X1,00-16		
5	710374		3	ECROU FI 6X1,00		
6	705097		3	VIS EPAULEE A EMBASE H M6X1,00-17		
7	727291		1	PLAQUE RENFORT DE GARDE-BOUE		
8	837013		2	ECROU ELS EMBASE 6X1,00		
9	853086		3	BONDELLE PLATE 6,2-12-1		
10	853466		1	BONDELLE PLATE 5,25-14-1,5		
11	713484		1	FORTE-SAGAGES		
12	711860	*	1	PLATE-FORME (N)		
13	726207	*	2	VIS ELS M5X0,80-14		
14	934007		2	ECROU FI 5X0,80		
15	703207		3	CALE ADHESIVE DOUBLE FACE		
16	713483		1	SANDOW SIKRE-PAQUET		

© PEUGEOT MOTOCYCLES

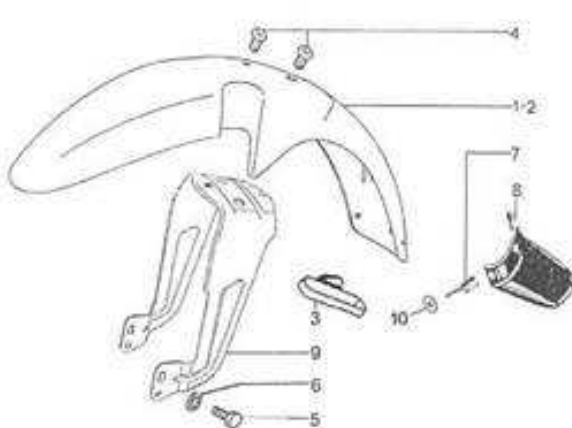
N°	REF. C	QTE	DESIGNATION	GARDE BOUE AVANT	C 08
1	726530 *	1	GARDE BOUE AVANT (PEINT)	<p>* NE PAS OMETTRE DE PRECISER LE COLORIS</p> 	
2	727964 *	1	GARDE BOUE AVANT (TEINTE MASSE)		
3	728382	2	GUIDE		
4	726208	2	VIS RILXS M6X1,00-14		
5	801119	2	VIS B M6X1,00-10		
6	716162	2	BONDELLE RESSORT G,1-14-1,3		
7	716804	3	PLASTI-RIVET		
8	727821 *	1	NAVETTE		
9	726531	1	PONT SUPPORT DE GARDE-BOUE		
10	860001	3	BONDELLE RILSAN 5-13-1		

© PEUGEOT MOTOCYCLES

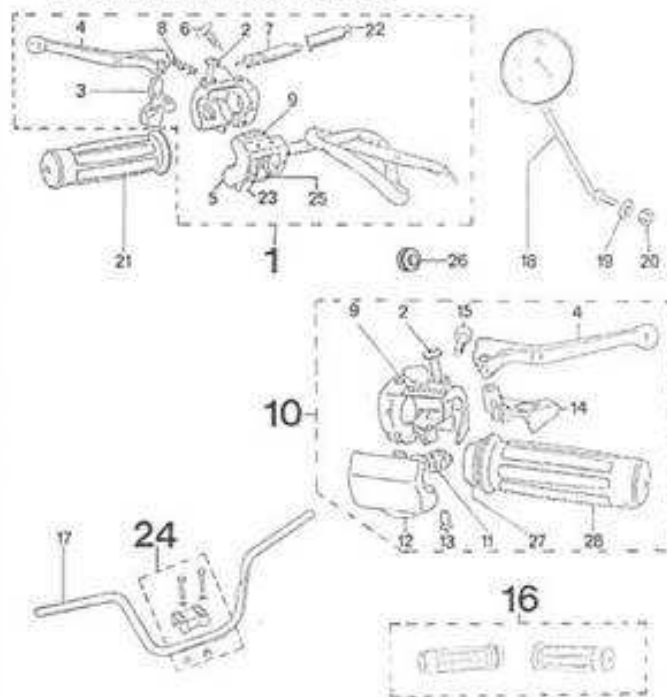
N°	REF. C	QTE	DESIGNATION	GUIDON-POIGNES-RETR	C 09
1	729609	1	POIGNEE GAUCHE	<p>* NE PAS OMETTRE DE PRECISER LE COLORIS</p> 	
2	65238	2	VIS AXE DE LEVIER DE FREIN		
3	752555	1	GACHETTE DE POIGNEE GAUCHE		
4	750636	2	LEVIER DE FREIN PLASTIQUE		
5	717861	1	COUVERCLE AVEC PAISCRAN		
6	728719	2	VIS RILXS 3-10		
7	63357	1	CONTACTEUR DE STOP		
8	752424	1	RESSORT DS L-24		
9	750733	2	DECOR *PEUGEOT*		
10	728535 *	1	POIGNEE DROITE		
11	65242	1	NAVETTE		
12	710494	1	COUVERCLE DE POIGNEE		
13	65254	1	VIS AXE DE NAVETTE		
14	752587	1	GACHETTE DE POIGNEE DROITE		
15	809002	1	VIS CSC M6X1,00-20		
16	750729	1	PAIRIE DE REVETEMENTS NOIRS		
17	52711	1	GUIDON		
18	715730	1	RETROVISEUR NOIR		
19	725083	1	BONDELLE CONIQUE 8,4-16-1,4		
20	710372	1	ECROU H 8X1,25		
21	51921	1	REUVETEMENT CAOUTCHOUC		
22	56310	1	CAPUCHON		
23	51856	1	BOUTON AVERTISSEUR		
24	750262	1	COLLIER AVEC FIXATION		
25	752058	1	BOUTON ECLAIRAGE		
26	873108	1	PASSE-FIL 11-8		
27	65245	1	TUBE		
28	51920	1	REUVETEMENT CAOUTCHOUC		

© PEUGEOT MOTOCYCLES

N°	REF. C	QTE	DESIGNATION	ROUE-MOYEU AR. TRANSM	C 10
1	733705 *	1	ROUE AR. 3875 HELICE	<p>* NE PAS OMETTRE DE PRECISER LE COLORIS</p>	
2	752794	1	PLATBAU DE FREIN ARRIERE D=90		
3	752793	1	JEU DE MACCHOIRES + BRESSORT D=90		
4	706550	6	VIS A ENCLASSE M 6X1,00-33		
5	710374	6	ECROU FI 6X1,00		
6	858051	6	BONDELLE BRESSORT 6-12-1,2		
7	735470	1	COUROMNE ARRIERE 54 DENTS		
8	726528	1	ENV.2.3/4-16 (NON DISPONIBLE)		
9	752793	1	AXE DE MOYEU D=12 L=162		
10	703512	2	ROULEMENT A BILLES 12-32-10		
11	752792	1	ENTRETOISE L=65		
12	710524	2	FATTE DE TENSION		
13	710574	2	ECROU FI 6X1,00		
14	724638	1	VALVE		
15	707365	1	ENTRETOISE 12X23-25X27,4		
16	69278	2	ECROU E 12X1,00 H=10 19/PLAT		
17	720266	1	CHAENE MOTEUR 105M+1 (DELTA)		
18	18519	1	ATTACHE RAPIDE A,88		

© PEUGEOT MOTOCYCLES

N°	REF. C	QTE	DESIGNATION	ROUE-MOYEU-AVANT	C 11
1	733692 *	1	ROUE AV. 3875 HELICE	<p>* NE PAS OMETTRE DE PRECISER LE COLORIS</p>	
2	752796	1	PLATEAU DE FREIN AVANT D=103		
3	752789	1	JEU DE MACCHOIRES D=100		
4	752800	1	AXE DE ROUE D=11 L=158		
5	752791	1	JEU DE COUVERTES		
6	693	20	BILLE D=6,35		
7	724638	2	VALVE		
8	44922	1	ECROU HM 11X1,00		
9	45847	2	ECROU E 11X1,00 H=10 19/PLAT		
10	726182	1	ENTRETOISE 16X13X10		
11	853108	2	BONDELLE PLATE 11,5-22-3		
12	726320	1	ENV.2.1/2-16 (NON DISPONIBLE)		

© PEUGEOT MOTOCYCLES

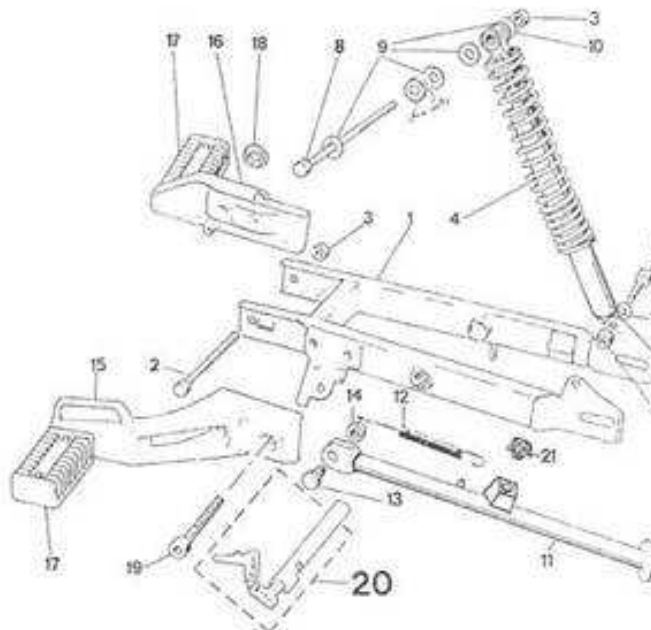
N°	REP.	C	QTE	DESIGNATION	SUSPENSION-BEQUILLE	C 12
1	726264 *		1	BRAS DE SUSPENSION	<p>* NE PAS OMETTRE DE PRECISER LE COLORIS</p> 	
2	714447		1	VIS H M10X1,00-143		
3	711024		2	ECROU H 10X1,00		
4	704028 *		2	AMORTISSEUR L=370		
5	710297		2	VIS H M8X1,25-35		
6	837011		2	ECROU EL5 EMBASE 4X1,25		
7	726245		2	BONDELLE CONTACT 8,2-22-1,6		
8	801296		1	VIS H M10X1,00-172		
9	853105		4	BONDELLE PLATE 10,25-20-1,5		
10	853116		1	BONDELLE PLATE 10,25-20-4		
11	720912		1	BEQUILLE LATERALE		
12	37513		1	RESSORT DE BEQUILLE		
13	750659		1	VIS H M10X1,50-30		
14	834012		1	ECROU FI 10X1,50		
15	716243 *		2	EXPOSE PIED GAUCHE SANS REVETEMENT		
16	716244 *		1	EXPOSE PIED DROIT SANS REVETEMENT		
17	716401		2	MANCHON CAOUTCHOUC		
18	717492 *		1	BOUCHON DE PROTECTION		
19	706386		2	VIS CHC M8X1,25-20		
20	712041		1	BARRIERE ANTIVOL L=145		
21	888009		1	BUTEE CAOUTCHOUC		

© PEUGEOT MOTOCYCLES

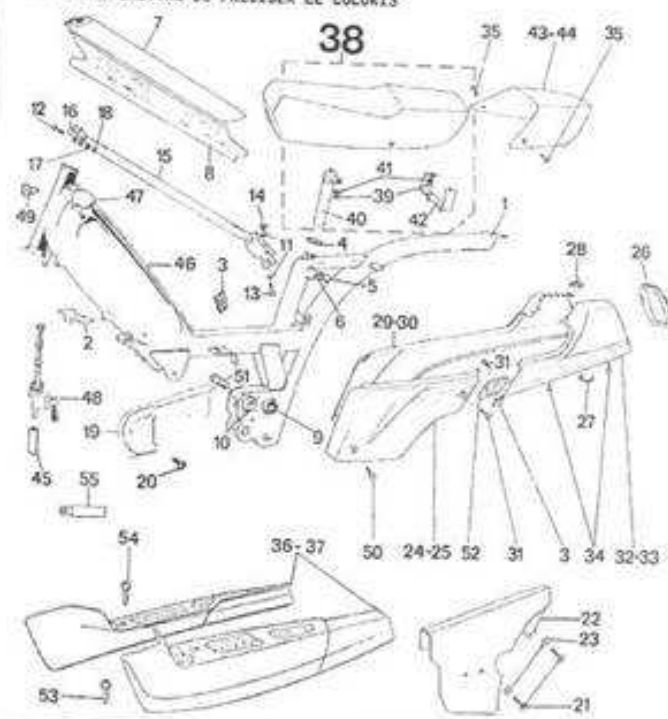
N°	REP.	C	QTE	DESIGNATION	CHASSIS-SELLE-CAPOTS	C 13
1	752937 *		1	CHASSIS	<p>* NE PAS OMETTRE DE PRECISER LE COLORIS</p> 	
2	58359		2	AGRAFE		
3	708381		7	ECROU TOLX 5X0,80		
4	716274 *		1	COQUELLE PROTECTRICK		
5	801241		1	VIS H M8X1,25-45		
6	853100		1	BONDELLE PLATE 8,25-16-1,5		
7	718559		1	PROTECTEUR DE KEMPORT		
8	718580 *		1	ENVELOPPE PROTECTRICK		
9	44312		1	SILENTBLOC		
10	52269		2	DOUILLE A AIGUILLES L=18		
11	46869		2	BONDELLE PLATE 7,2-13-1,5		
12	801137		2	VIS H M8X0,80-25		
13	801245		1	VIS H M7X1,00-60		
14	710813		1	ECROU H 7X1,00		
15	718558 *		1	KEMPORT		
16	718662 *		1	DEMI-COLLIER		
17	853101		2	BONDELLE PLATE 5-10-1		
18	834007		2	ECROU FI 5X0,80		
19	716410 *		1	PARC-CHAINE		
20	726456		2	VIS T45 ELIX 4-14		
21	725507		2	VIS SE M5 X 0,80 - 10		
22	727040 *		1	ENS PARC-CHAINE		
23	853349		2	BONDELLE PLATE 5,25-12-1		
24	718962 *		1	COFFRE (PEINT)		
25	752966		1	COFFRE (TEINTE MASSE)		
26	715026		1	ENTOURAGE MOUSSE		
27	720553		1	AGRAFE		
28	883020		1	COLLIER PLASTIQUE DE 3,6 L=208		
29	718552 *		1	COQUE ARRIERE DROITE (PEINT)		
30	752964		1	COQUE ARRIERE DROITE (TEINTE MASSE)		
31	708764		2	VIS EL M5X0,80-14		
32	718553 *		1	COQUE ARRIERE GAUCHE (PEINT)		
33	752965		1	COQUE ARRIERE GAUCHE (TEINTE MASSE)		
34	726457		2	VIS CELES 4-14		
35	708765		2	VIS EL M5X0,80-18		
36	752944 *		1	PAIRE DE CAPOTAGES (PEINT)		
37	752929 *		1	PAIRE DE CAPOTAGES (TEINTE MASSE)		
38	718551 *		1	SELLE (AVEC FIXATION)		
39	710372		4	ECROU H 8X1,25		

© PEUGEOT MOTOCYCLES

SUITE SUR VUE C 14

N°	REP.	C	QTE	DESIGNATION	CHASSIS-SELLE-CAPOTS	C 14
40			1	TIGE DE SELLE	<p>* NE PAS OMETTRE DE PRECISER LE COLORIS</p>	
41			4	BONDELLE DENTURE EXTERIEURE D=8		
42			1	SUPPORT ARRIERE DE SELLE		
43			1	COUVRE SELLE (PEINT)		
44			1	COUVRE SELLE (TEINTE MASSE)		
45			1	TUYAU (AU METRE)		
46			1	EMPOLIVEUR CENTRAL		
47			1	SOUCHEON DE RESERVOIR		
48			1	ROBINET D'ESSENCE		
49			2	ELVET AVEUGLE 3,2		
50			2	VIS RL M3X0,80-45		
51			1	GRAISSEUR		
52			1	PATTE		
53			1	VIS RLX M3X0,80-12		
54			2	VIS RLX M3X0,80-20		
55			1	RALLONGE DE CON. ROBINET		

© PEUGEOT MOTORCYCLES

N°	REP.	C	QTE	DESIGNATION	EQUIPEMENT ELECT.	C 15
1			1	FAISCEAU PRINCIPAL (NON REPRESENTE)		
2			1	COMBUTATEUR ECLAIRAGE/AVERTISSEUR		
3			1	CONTACTEUR DE STOP		
4			1	CAPOCHON		
5			1	TRANSFORMATEUR *G*		
6			1	ENTRETOISE		
7			1	VIS H MAX1,00-20		
8			1	BONDELLE PLATE 6.2-12-1		

© PEUGEOT MOTORCYCLES

N°	REF. C	QTE	DESIGNATION	GARDE-BOUJ ARRIERE	C 16
1	718555 *	1	GARDE-BOUJ ARRIERE	<p>* NE PAS OMETTRE DE PRECISER LE COLORIS</p>	
2	708381	3	ECROU TOLE 5X0,80		
3	710282	1	VIS H M5X0,80-16		
4	853466	1	BONNETTE PLATE 5,25-14-1,3		
5	715235 *	1	BAVETTE GARDE-BOUJ		
6	713008	2	CATADIOPTE		
7	726207	2	VIS ELKS M5X0,80-14		
8	853466	2	BONNETTE PLATE 5,25-14-1,3		
9	65857	2	ECROU FILTREUR 5		

© PEUGEOT MOTOCYCLES

N°	REF. C	QTE	DESIGNATION	GUIDON-POIGNONS-REIN	D 01
1	727327 *	1	POIGNEE TOURNANTE DROITE	<p>* NE PAS OMETTRE DE PRECISER LE COLORIS</p>	
2	66574	1	PROTECTEUR DE TENDEUR		
3	704355	2	VIS CBC M5X0,80-16		
4	711947 *	1	LEVIER DROIT AVEC SUPPORT		
5	750225	1	LEVIER DROIT		
6	710374	2	ECROU FI 6X1,00		
7	750222	2	RESSORT DE POIGNEE		
8	750221	2	VIS AXE DE LEVIER DE FREIN		
9	750223	2	ENTRETOISE		
10	809033	2	VIS CBC M6X1,00-16		
11	717402 *	1	LEVIER DE DECOMPRESSEUR		
12	712878	2	BARILLET		
13	751425	1	COUVERCLE DE POIGNEE DROITE		
14	717354 *	1	LEVIER GAUCHE AVEC SUPPORT		
15	750220 *	1	LEVIER GAUCHE		
16	751356 *	1	LEVIER DECOMPRESSEUR/AIR		
17	63357	1	CONTACTEUR DE STOP		
18	717734 *	1	GUIDON		
19	750262	1	COLLIER AVEC FIXATION		
20	715711	1	RETROVISEUR NOIR		
21	56310	1	CAPUCHON		
22	720890 *	1	REVETEMENT POIGNEE GAUCHE		
23	751973	1	BOULETTE DE POIGNEE DE GAZ		
24	718883	1	TENDEUR		
25	752345 *	1	PAIRE DE REVETEMENTS (NOUV. MODELE)		

© PEUGEOT MOTOCYCLES

N°	REF. C	QTE	DESIGNATION	SUSPENSION-BEQUILLE	D 02
1	726265 *	1	BRAS DE SUSPENSION	<p>* NE PAS OMETTRE DE PRECISER LE COLORIS</p>	
2	714447	1	VIS H M10X1,00-143		
3	711024	2	ECROU H 10X1,00		
4	853088	1	RONDELLE PLATE 10,5-20-1,7		
5	853116	3	RONDELLE PLATE 10,25-20-4		
6	710962	1	BOUCHON PROTECTION DE 10		
7	711895 *	2	AMORTISSEUR L=370		
8	710297	2	VIS H M8X1,25-35		
9	837011	2	ECROU ELS EMBASE 8X1,25		
10	726145	2	RONDELLE CONTACT 8,2-22-1,6		
11	801296	1	VIS H M10X1,00-172		
12	720912	1	BEQUILLE LATERALE		
13	37513	1	RESSORT DE BEQUILLE		
14	750639	1	VIS H M10X1,50-30		
15	834012	1	ECROU FI 10X1,50		
16	715352	1	PAIRE DE REPOSE-PIEDS		
17	715351	2	AKK		
18	880004	4	CLIP DX MAINTIEN D=5		
19	712041	1	BARREAU ANTIVOL L=145		
20	880009	1	BUTEX CAOUTCHOUC		
21	853105	2	RONDELLE PLATE 10,25-20-1,5		

© PEUGEOT MOTOCYCLES

N°	REF. C	QTE	DESIGNATION	ECLAIR-CLIGNOT-AVERT	D 03
1	733232	1	BLOC OPTIQUE AVEC AMPOULE	<p>* NE PAS OMETTRE DE PRECISER LE COLORIS</p>	
2	47008	1	AMPOULE BLANCHE 6V-15W P205		
3	732785	2	VIS ELXS 4-12		
4	751719 *	1	CARENAGE DE FREIN AVEC CATADIOPTRIS		
5	716882	1	BRIDE		
6	728540	3	VIS ELXS 4-20		
7	716933	1	CATADIOPTRIS GAUCHE		
8	716934	1	CATADIOPTRIS DROIT		
9	731255	1	AVERTISSEUR		
10	726479	2	VIS T45 ELXS 4-10		
11	718527	1	LANTERNE ARRIERE		
12	57692	1	AMPOULE BLANCHE 6V-4W BA9S		
13	57693	1	AMPOULE BLANCHE 6V-10W BA15S		
14	751503	1	CAROCCHON		
15	751154	2	VIS DX CASOCHON L=54		
16	718526	1	PLAQUE SUPPORT FREIN AR.		
17	728544	2	VIS ELXS M8X0,80-20		
18	834007	2	ECROU FI 5X0,80		
19	801102	2	VIS H M6X1,00-20		
20	61638	2	DOUILLE KFAULEK		
21	873108	2	PASSE-FIL 11-8		
22	832097	2	ECROU SM 6X1,00		
23	853086	2	RONDELLE PLATE 6,2-12-1		
24	853466	1	RONDELLE PLATE 5,25-14-1,5		
25	873223	1	PASSE-GAINE 11-8		
26	705423	1	DOUILLE		

© PEUGEOT MOTOCYCLES

